

Aus  
Überzeugung.

## TRANSLATION OF THE ORIGINAL GERMAN OWNER'S MANUAL E-BIKES

---



## **DEAR CUSTOMER,**

Thank you for choosing one of our E-Bikes. Riese & Müller manufactures light-weight and practical E-Bikes featuring impressive riding dynamics and a sensible conceptual design. This manual answers important questions and provides many tips for handling your E-Bike.

Your dealer has carefully assembled the E-Bike and possibly made some modifications according to your requests. They have completed a test ride to make sure that you are able to fully enjoy riding your E-Bike from the moment you first get on. Should you be unsure about anything after reading this manual and you have further questions, please contact your specialist dealer or us directly.

**YOUR RIESE & MÜLLER TEAM**



---

# CONTENTS

---

<b>4</b>	General information
<b>5</b>	Safety information
<b>6</b>	Legal requirements
<b>7</b>	Legal provisions for fast E-Bikes
<b>8</b>	Intended use
<b>10</b>	Before the first ride
<b>12</b>	Before every ride (quick check)
<b>14</b>	Quick release skewers
<b>15</b>	Adjusting the seat position
<b>16</b>	Adjustable stem
<b>18</b>	Adjusting the suspension
<b>20</b>	Brake system
<b>25</b>	Gear
<b>26</b>	Chain, belt drive
<b>27</b>	Wheels and tires
<b>30</b>	Repairing a flat tire
<b>30</b>	Stand
<b>31</b>	Lighting system
<b>32</b>	Luggage and child transport
<b>33</b>	Integrated cable lock
<b>34</b>	Bosch drive
<b>36</b>	E-Bikes – range in cold weather
<b>37</b>	E-Bike transport
<b>38</b>	General care instructions
<b>40</b>	Inspections
<b>42</b>	Legal warranty / guarantee
<b>45</b>	Weight specifications
<b>46</b>	Tightening torques for screw connections
<b>48</b>	Service and maintenance plan
<b>50</b>	Important documents
<b>51</b>	Handover documentation for customer and dealer
<b>52</b>	E-Bike Logbook

Carrier, p. 32

Suspension, p. 18

Lighting system, p. 31



Brake system, p. 20

Bosch drive, p. 34

Chain, belt drive, p. 26

Gear, p. 25

Quick-release  
skewers and axles, p. 14

Wheels, tires, p. 27

Stand, p. 30

Adjustable stem, p. 16

Luggage and child transport, p. 32

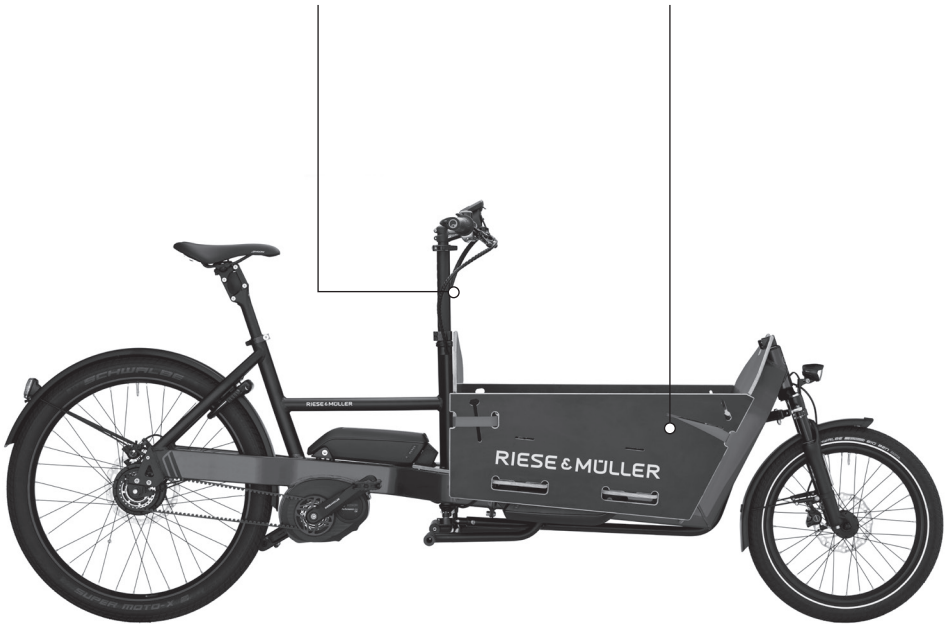

## DANGER!

*Tightening torques are specified in Nm in this manual. Never rely on your impression: “Tight” doesn’t equal “tight”. ONLY a torque spanner can ensure that bolts are tightened correctly. Therefore always use such a spanner and observe the torques specified in this manual. Bolts that have been tightened insufficiently or too tightly can lead to cracks. These can cause falls, possibly with severe injuries.*

---

# GENERAL INFORMATION

---

Carefully read **all** the instructions that come with this E-Bike before the first ride. Please observe the following symbols:

 **Attention!** Note which helps you to quickly familiarise yourself with your E-Bike and its technology.

 **Danger!** Possible dangers for your life and health if respective calls to action are ignored.

 **Note! / Tip!** Meaningful additional information

 Use **torque spanner** and observe specified torques

These symbols will be used from now on without their meaning being explained every time.

For your own safety perform the quick check before every ride. Please refer to page 12 for details on how to do this.

## **DANGER!**

*This manual includes assembly and maintenance work which may need to be done before a required inspection is due, which needs to be carried out by a specialist dealer (see page 40). Never perform work on your E-Bike beyond this. It requires specialist knowledge, tools and skills which is why it can only be carried out by a specialist dealer. Never ride your E-Bike if assembly work has been carried out incompletely or improperly. This would compromise your own safety and that of other cyclists and motorists.*

---

## **ATTENTION!**

*Before using your E-Bike, carefully read the supplied Bosch instructions. It is vital you follow all the safety instructions.*

---

In case of questions please contact your specialist dealer.

**WE HOPE YOU ENJOY YOUR NEW RIESE & MÜLLER E-BIKE.**

---

# SAFETY INFORMATION

---



## **DANGER!**

*When getting onto your bike with the assistance mode turned on, remember that the E-Bike will start moving as soon as you put your foot on the pedal. Apply the brakes first as the unfamiliar push can cause a hazard or accident.*



## **DANGER!**

*Switch off the E-Bike system and take out the battery before carrying out any work on your E-Bike, e.g. assembly or maintenance work, or before transporting it. Unintentional activation of the E-Bike system poses a risk of injury.*

---

# LEGAL REQUIREMENTS

---

In most European countries, the same rules apply for E-Bikes up to 25 km/h as for conventional bicycles with regard to road traffic. Nevertheless, there may be deviations (e.g. minimum age of the rider).



## NOTE!

*Find out about the statutory regulations applicable in your country prior to your first ride (e.g. by consulting your specialist dealer).*



---

# LEGAL PROVISIONS FOR FAST E-BIKES

---

Fast E-Bikes up to 45 km/h are classed as vehicles in the EU, which legally requires riders to wear a helmet as well as to have a licence and insurance cover. As a general rule, child trailers are not allowed to be used with fast E-Bikes. Children may only be transported in suitable child seats.

Your vehicle's technical design is defined by Riese & Müller's technical certification. Modifications and additions of certain components to your fast E-Bike thus lead to the operating licence being void.

---

# INTENDED USE

---

Your Riese & Müller E-Bike is designed for the use on roads and paved paths only. You should therefore never ride on stairs, jump or perform wheelies or similar activities.

The Mountain models are the only exception to this. Experienced riders can use these on dirt roads and jump from a maximum height of 30 cm.

Riese & Müller E-Bikes are not approved for participation in competitions.

Commercial use does not form part of the intended use.

Operating, maintenance and service instructions described in this manual are part of the intended use.

No liability or warranty shall be accepted if the use of the E-Bike deviates from this intended use, if safety instructions are not observed, in the event of overloading or if faults are not properly rectified. Similarly, no liability and warranty shall be accepted in the case of assembly errors, wilful intent, accidents and if the care and maintenance specifications are not complied with. Any modification of the gear transmission ratios and alterations to the electrical system (tuning) voids all claims under warranty and guarantees.



## **DANGER!**

*Your E-Bike is generally only approved to transport a single rider, with the exception of transporting a child in a suitable child seat or trailer. Follow the regulations applicable to your country. Please observe the permitted overall weight (see page 45) and the tongue load.*



## **NOTE!**

*Permitted overall weight =  
Rider weight +  
Bike weight +  
Luggage weight +  
Trailer weight*

---

# BEFORE THE FIRST RIDE

---



## ATTENTION!

*Your specialist dealer must provide the E-Bike in a condition ready to ride in order to ensure safe operation. The dealer must perform a final inspection and a test ride. Handover of the E-Bike must be documented in the E-Bike Logbook (see pages 51 and 53).*

*Check the tightness of the quick-release skewers and all main fixing screws and nuts.*

*Check the tires' air pressure. The specified tire pressure is stated on the side wall of the tires. Comply with the specifications for minimum and maximum pressure! Check the tires and wheels for damage, cracks and deformation.*

*Check the battery is inserted securely. Check the charge status of the battery.*

*Familiarise yourself with the functions of all controls.*

---



## DANGER!

*If the assistance mode is turned on your E-Bike will start moving as soon as you put your foot on the pedal. When getting onto your bike you should therefore make sure you apply the brakes first and don't put your foot on a pedal. The unfamiliar push can otherwise cause a fall, hazard or accident.*

## CARRIERS, CHILD SEATS

Please note that it is not permitted to modify carriers in any way. Only use tested and approved child seats.

## TRAILER/TRAILERBIKES

Full-suspension Riese & Müller E-Bikes are only approved for use with two-wheel trailers. The maximum trailing load (trailer incl. cargo load) is 50 kg. If attached to the carrier, the tongue load needs to be added to the carrier's load.

Riese & Müller E-Bikes without rear wheel suspension are also approved for use with single wheel trailers. The maximum trailing load is 20 kg for all models.

---

---

## BRAKE SYSTEM

Check that the configuration of the brake lever matches what you are used to. Otherwise your specialist dealer should adjust the configuration of the brake levers. Further information on the brake system from page 20.



### DANGER!

*Modern brakes are far more effective than simple rim or drum brakes. Make sure to test the brakes away from traffic first. Careless braking can cause a crash. Slowly approach stronger braking.*



### DANGER!

*Riding behaviour is altered by a full load and the braking distance is longer. For this reason we recommend testing the riding and braking behaviour with and without a load first in order to get used to the differences in behaviour.*

## GEAR

Familiarise yourself with the new gear in a safe place away from traffic. Further information on the gear on page 25.

## SEAT POSITION

Ask your specialist dealer to adjust and explain the ideal seat position.



### DANGER!

*If your E-Bike has been fitted with rubber or plastic cage pedals, familiarise yourself with the support they provide. Rubber and plastic pedals get slippery when wet.*

## SUSPENSION

Ask your specialist dealer to adjust and explain the suspension.



### NOTE!

*Carry out all the checks specified in section “Before every ride”.*

---

# BEFORE EVERY RIDE (QUICK CHECK)

---



## **DANGER!**

*Only ride your bike if it passed all the steps of the quick check. In case of doubt, see your specialist dealer. A defective E-Bike can cause accidents.*



## **ATTENTION!**

*After a fall or accident only start using your E-Bike again once your specialist dealer has checked it for possible damage.*

---

## **QUICK-RELEASE SKEWERS / SCREW CONNECTIONS / QUICK-RELEASE AXLES**

Check all quick-release skewers, axles and screw connections are secure, even if you have only left your bike unattended briefly. Only set off if all fasteners are firmly closed.



## **DANGER!**

*Quick-release skewers and screw connections that have not been tightened properly can result in component failure and serious accidents.*

*Check all quick-release skewers, axles and screw connections are secure, even if you have only left your bike unattended briefly. Only set off if all quick-release skewers are firmly closed.*

---

---

## WHEELS

Check the tires' condition and air pressure. Further information on page 27. The wheels should run easily with sufficient truth.

## LIGHTING

Check if the front and rear lights are working properly and if the front light is set correctly. This is explained on page 31.

## BRAKES

Pull both brake levers. You should feel an obvious pressure point and the levers should not be able to touch the handle.

## LOAD

Make sure your cargo has been firmly secured. Loads must be secured and there must not be any loose fasteners that could get caught in the wheels. Do not load your E-Bike more on one side than on the other. Do not cover lighting and reflectors. Bear in mind that the riding behaviour may be different when transporting a load.

## OVERALL WEIGHT

Make sure that you don't exceed the permitted overall weight (page 45).

## BOSCH BATTERY

Ensure that the battery is properly in place each time it is inserted. Push the battery into its holder until it clicks into the lock. Remove the key from the lock and pull the battery to check if it has indeed locked into place.



### DANGER!

*Batteries that have not been fully inserted can come loose during a ride and fall out. This can cause a crash and damage the battery.*



### DANGER!

*On E-Bikes with two batteries, one of them is attached to the frame. Make sure you hold the battery with one hand before turning the key in the lock. Otherwise the battery will come off and fall down. This can cause injuries and damage the battery.*

# QUICK RELEASE SKEWERS

## DESIGN OF QUICK-RELEASE SKEWERS

- Hand lever **A** on one side. It generates a clamping force.
- Clamping nut **B** on the opposite side.  
This is used to set an initial tension on the threaded rod. In some cases there is also a screw instead of the clamping nut and threaded rod.

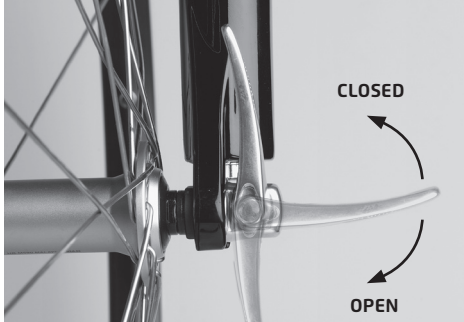

## DANGER!

*Never ride an E-Bike without first having checked that the wheel is securely fixed. Should the wheel come loose during the ride this will cause a crash.*

## HANDLING QUICK-RELEASE SKEWERS

- Open lever **A**. It should be possible to read the writing "Open".
- To close move the lever so it shows the writing "Close". The lever should move easily, i.e. without clamping effect, at the beginning of the motion until around halfway.
- The lever force should increase significantly in the second half of the motion. Towards the end, the lever can hardly be moved at all. Use the ball of your thumb. In the end position "closed", the lever needs to be parallel to the wheel, pointing backwards. In other words, it may not stick out to the side.
- Make sure it is secure by trying to move the closed lever. If it is possible to rotate it, the wheel is not sufficiently secured. You need to reopen the lever and increase the initial tension. In order to do this, tighten the clamping nut **B** by half a turn (holding the quick-release skewer tight).
- Try twisting the stem or saddle in order to check the respective quick-release skewer.

## QUICK RELEASE AXLES

Some Riese & Müller models are fitted with a quick-release axle at the front and/or rear wheel. In principle, quick-release axles work like quick-release skewers with a thread in the suspension fork or the rear swing arm taking on the task of the clamping nut.



# ADJUSTING THE SEAT POSITION



## DANGER!

*Setting the E-Bike to suit your needs requires experience, suitable tools and manual skills. All adjustments should therefore be made by a specialist dealer.*



## DANGER!

*Never ride your bike if the seatpost has been pulled out beyond the mark on the shaft. The mark mustn't be visible above the upper edge of the seat tube. Otherwise the post could break or the frame could be damaged. After potentially shortening the seatpost a minimum of 80 mm has to remain in the frame.*



## DANGER!

*When changing the saddle, make sure that the seatpost is designed for a saddle rail with a diameter of 7-8 mm. Any other type of rail can cause component failure and a crash.*



## DANGER!

*Adjusting the height of A-Headset stems requires changes to be made to the headset. Should this work be carried incorrectly it poses a high danger of accidents. For this reason you should get your specialist dealer to perform this task.*

---

# ADJUSTABLE STEM

---

Some Riese & Müller E-Bikes are fitted with an adjustable stem. Thanks to snap-in locking and quick-release skewer it can be adjusted without tools.

## Adjusting the angle

- Open both quick-release skewers **A** at the stem joint.
- Push the sliding knob **B** on the side and adjust the stem to one of the three angular positions. Let go of the knob for it to lock back into place (if necessary slightly move the stem forwards and backwards).
- Attention: Only the three stem positions with engaged pin can be used.
- Always close the quick-release skewer **A** on the side of the pin **B** first. The lever force should increase significantly in the second half of the motion.
- Once engaged, the red lines **E** on the side of the stem joint need to line up.

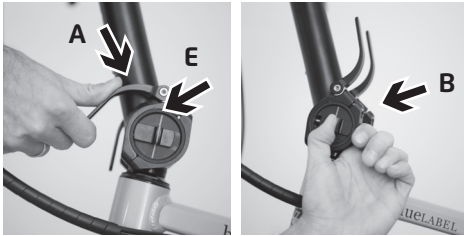

## Height-adjustment:

- Open the quick-release skewer **C**.
- Push the pin **D** and adjust the stem to one of the five height positions until the pin **D** locks back into place.
- Straighten the handlebars to align with the direction of travel and close the quick-release skewer **C**. The lever force should increase significantly in the second half of the motion. If the clamp force is not

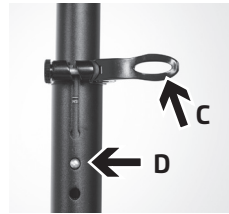

sufficient, the specialist dealer must adjust the quick-release skewer.

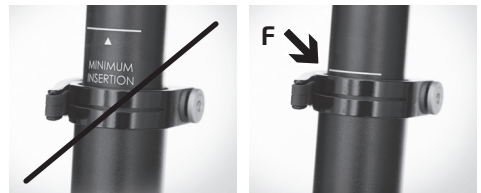

## ! ATTENTION!

*The stem must not be pulled out further than the "MIN. INSERTION" mark F. Only the five height positions with locked-in pin can be used.*

---

## ! ATTENTION!

*Before every ride, ensure that the pins are correctly engaged and the quick-release skewers closed completely. Should the handlebars or the stem move while riding, do not continue. Immediately take your bike to your specialist dealer to get the stem checked. This could otherwise lead to crashes and serious injuries.*

---

## ADJUSTING THE HANDLEBARS' INCLINATION

Adjust the handlebars to ensure your wrists remain relaxed without overly twisting them. The position of the handlebars is altered by rotating them in the stem.

- If the Bosch Display covers the handlebar clamp bolts, you first have to slightly loosen the display's four bolts by a few turns and twist it.
- Loosen the four bolts **A** and **B** or the four bolts **H** of the handlebar clamp by a few turns.
- Adjust the handlebars to the desired position.
- Make sure that the stem clamps the handlebars exactly in the middle.
- In case of an adjustable stem, first tighten each screw **A** on the side of the writing with a torque of 6-8 Nm. Then tighten the screws **B** on the opposite side with 6-8 Nm.
- Align the Bosch Display correctly and retighten the bolts.

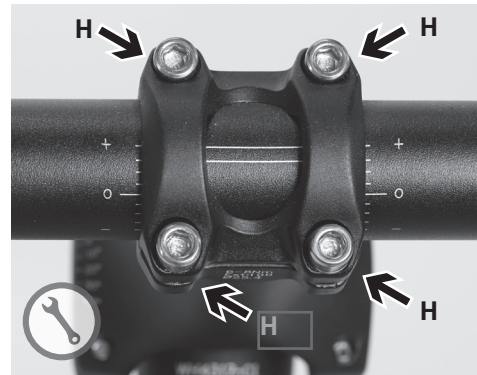

### DANGER!

*After making changes to the position of the handlebars and stem make sure that all cables and housings are still long enough. You need to be able to perform all steering movements smoothly and safely.*

---

# ADJUSTING THE SUSPENSION

---



## DANGER!

*If you don't have the specialist knowledge or tools to adjust the suspension or if you are unsure, it is vital to contact your specialist dealer.*

### AIR SUSPENSION

For air suspension elements the preload can be adjusted by means of air pressure with the supplied suspension fork pump. Please refer to the separately supplied component manufacturer's manual for further details.

Some suspension elements can be blocked by means of a lever. Please observe the information provided in the separately supplied suspension manufacturer's manual.



## ATTENTION!

*The suspension alters the distance between the pedal and the ground during rides.*

*When going into a bend or when riding over bumps in the road, keep the crank arms in a horizontal position to prevent the pedals from touching the ground.*

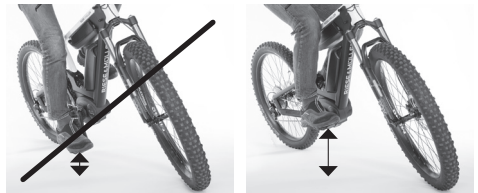

## DANGER!

*Practice how to prevent the pedals from touching the ground. Practice while riding slowly and away from traffic as pedals touching the ground can cause a fall and thus serious injuries.*

---

---

## MAINTAINING THE SUSPENSION

For suspension forks with a steel spring you can adjust the degree of suspension to your weight by means of a rotary knob.



Should the range of adjustment not suffice, please contact your specialist dealer.



### **DANGER!**

*When noticing an increasing resistance while turning in “-” direction, you need to stop. Otherwise the screw connection could come loose. Danger of accidents!*

Some suspension elements can be blocked by means of a lever. Please observe the information provided in the separately supplied suspension manufacturer’s manual.

---

# BRAKE SYSTEM

---

The brakes on Riese & Müller E-Bikes enable you to achieve a high braking performance with little effort in any situation. The braking distance, however, also depends on your riding skills, which can be learned. While braking the weight is shifted to the front and the rear wheel is relieved. The rate of deceleration is limited primarily by the danger of the E-Bike overturning and only secondarily by the grip of the tires. This problem is worse when riding downhill. When braking fully, you must attempt to shift your weight as far back as possible.

Pull both brakes at the same time and note that the front brake can transfer far greater forces.

If you need to brake heavily on loose surfaces such as sandy soil, the front brake must be applied slowly and intermittently to avoid uncontrolled slipping.



## DANGER!

*Carefully familiarise yourself with the brakes. Practise emergency stops away from traffic until you are able to keep full control of your E-Bike. This can prevent accidents on the roads.*



## DANGER!

*Don't apply the brake lever if your bike is upside down or on its side. Otherwise air bubbles can get into the hydraulic system causing the brake to fail. Check after every transport if the brake's pressure point feels softer than before. If it does, slowly apply the brake a couple of times to bleed the brake system. If the pressure point remains soft, you cannot ride your bike and your specialist dealer will have to bleed the brake.*



## ATTENTION!

*Wet conditions reduce the braking performance. Expect longer braking distances in the rain. When replacing the brake pads only use approved pads which fit the rim/brake surface. Your specialist dealer will be happy to advise you. Make sure the rims/brake surfaces are free from wax, grease or oil.*

---



## NOTE!

*Please refer to the separately supplied brake manufacturer's manual for information about the brakes.*

## WEAR WITH RIM BRAKES

Friction during braking causes wear on the brake pads and the rim. Regularly riding in wet weather increases the rate of wear. If the edge of the rim is worn to a critical level, the tire pressure can cause the rim to burst. The wheel can lock up or the inner tube can burst – both cases can result in a crash. You should consult your dealer no later than when you have worn down the second set of brake pads. Your dealer can check the wall thickness of the rim. Rims with wear indicator A need to be replaced once the wear indicator is no longer visible.



## ATTENTION!

*Have a specialist check the rim at the latest after the second set of worn brake pads. Worn rims can cause material failure and serious accidents.*

---

---

# BRAKE SYSTEM

---

## DISC BRAKES



### DANGER!

*Brake disc and calliper can heat up considerably during the braking process. This applies in particular after frequent braking or long descends. Do not touch the brakes straight after braking to prevent burns.*

### Maintenance of disc brakes

Regularly test the brake system's braking performance and check for brake pad wear and tightness of the system. Brake pads need to be replaced if they are dirty or less than one millimetre thick. On no account should the carrier plate touch the brake disc.

### Vapour lock in disc brakes



### DANGER!

*Avoid permanently braking for a long period of time as might be the case during long, steep descends. Otherwise vapour lock can occur, leading to total failure of the brake system, which can cause serious crashes and injuries.*



### TIP!

*New brake pads must be bedded in for optimum braking performance and low wear. To do this, accelerate the bike to around 25 km/h and brake as hard as possible until you come to a complete stop. Repeat this about 30 times. The bedding-in process is completed once the manual force required for the best possible deceleration no longer decreases.*



### NOTE!

*Do not pull the brake levers after removing the wheels. This pushes the brake pads together and makes it difficult to re-fit the wheel. Use the transport locks provided after removing the wheels to ensure a sufficient gap between the brake pads.*

*Do not transport your E-Bike with the wheels up. This can cause the brakes to become ineffective.*





## **ATTENTION!**

- *Ask your specialist dealer to replace worn brake pads.*
  - *The braking performance of disc brakes can significantly be reduced by oil, care or cleaning fluids. When cleaning your E-Bike or greasing the chain, make sure that the brake pads and brake discs aren't affected. Greasy brake pads need to be replaced immediately, brake discs can be cleaned with a brake cleaner. Avoid touching the friction surface of brake discs or brake pads with your fingers.*
  - *Check the brake system for tightness or bent cable housings before every ride. The loss of brake fluid reduces the braking performance or even causes the brakes to fail. Immediately see a specialist dealer to repair any leaks.*
-

---

# BRAKE SYSTEM

---

## BACK-PEDAL BRAKE

Some Riese & Müller models are optionally fitted with a back-pedal brake at the rear wheel. Back-pedal brakes enable you to slow down the rear wheel by turning the crank backwards.

If your bike has been fitted with a back-pedal brake you can brake by pedalling backwards instead of forwards. The best brake action can be achieved when the crank arms are in a horizontal position. On long descends, the back-pedal brake's performance can decline significantly. The brake can heat up considerably through long braking.

Do not touch the brake after long or heavy braking due to the danger of burns.

Use the front brake on long descends as well to allow the back-pedal brake to cool down.



### DANGER!

*Check the brake anchor is secure before every ride and after any kind of assembly work. It must be secured to a bracket on the frame by a screw or slotted in a longitudinal hole by a screw head. This connection requires a tightening torque of 4-6 Nm.*



---

# GEAR

---

## **CORRECT SHIFTING**

When shifting on a bike with derailleur gear, it is important to keep pedalling consistently and effortlessly until the desired gear is engaged. Avoid shifting while pedalling strongly.

Hub gears (Rohloff, Shimano and NuVinci) are shifted without pedalling.



### **DANGER!**

*Practise shifting away from traffic. On the roads this would be too distracting.*



### **NOTE!**

*Please observe the information provided in the separately supplied gear manufacturer's manual.*



### **DANGER!**

*Adjusting the gear is a job for experienced mechanics only. Mis-adjustments can cause serious mechanical damage. Should you have any problems with the gear, please contact your specialist dealer. After a crash, accident or transport damage you should get the gear checked by a specialist.*

---

# CHAIN / BELT DRIVE

---

## CHAIN

### Chain care

Chains are wear parts, however, the rider can affect their service life. Make sure you regularly grease the chain, particularly before riding in the rain.

- Clean your chain with a dry cloth from time to time.
- Apply a suitable lubricant from a specialist shop to the chain links.

### Chain wear

Chains of derailleur gears can often reach their wear limit after approx. 1,000 to 3,000 km. You should therefore have your specialist dealer replace the chain at regular intervals.

### Checking the chain tension

For bicycles with hub gear and without additional chain tensioner, the chain tension needs to be checked at regular intervals and potentially readjusted by the specialist dealer.

## REPLACING the chain

- The chain should only be replaced by a competent person. If required, your dealer can fit the chain suitable for your E-Bike.



### DANGER!

*A chain that has not been fitted or tensioned correctly can come off or tear and cause a fall. Ask your specialist dealer to replace the chain for you.*

## BELT DRIVE

If your E-Bike is fitted with a belt drive, please observe the separately supplied Gates manual.

---

# WHEELS AND TIRES

---

The wheels of an E-Bike are under a lot of strain. After the first 200 to 400 km, your specialist dealer should check the wheels and true them if necessary. However, even after that you have to check your wheels regularly.

## TIRES AND AIR PRESSURE

Tires have to be inflated to the correct air pressure in order to work properly. The correct pressure also improves puncture resistance. The recommended air pressure is specified in bar and PSI on the tire or a label on the rim.



## ! TIP!

*Always ride with the required air pressure and regularly check it.*



## DANGER!

*Always inflate the tires to a pressure between the minimum and the maximum pressure allowed. Otherwise the tires could come off the rim or burst. Risk of falling!*

---

# WHEELS AND TIRES

---

## TUBE AND VALVE

Riese & Müller bikes use so-called Presta valves (also known as a Sclaverand or French valve). Before inflating, the small knurled nut on the end of the valve must be unscrewed slightly and then briefly pressed to the valve until some air escapes.

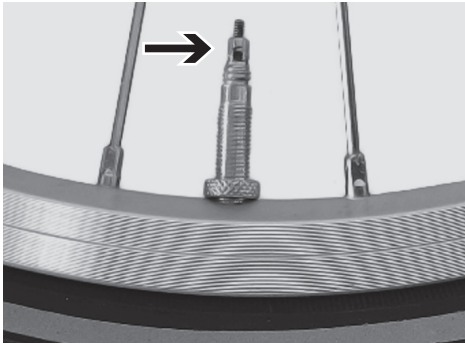

If the valve inserts in Presta valves are not completely tightened, this results in creeping air loss. Check the valve insert is securely seated in the valve stem. Make sure that the valve is straight.

## CHECKING THE TIRES

Regularly check the tires.



### **DANGER!**

*Tires with worn tread or brittle edges should be replaced by your specialist dealer. The structure of the inside of the tire can be damaged by moisture or dirt. Faulty rim bands (rim bands are located between the inner tube and rim) must be replaced immediately. In extreme cases, damage to the tires can result in the inner tube bursting suddenly, causing a crash.*

---

---

## CHECKING THE RIM TRUTH

Check the truth of the rim from time to time by lifting the wheel off the ground and spinning it by hand. Monitor the true running of the rim. If it changes visibly, the wheel should be trued by a specialist.



### DANGER!

*Do not ride on untrue wheels. In case of extreme deviations the brake pads of the rim brake may miss the rims and get into the spokes. Risk of falling!*



### TIP!

*Leave the truing of wheels to your specialist dealer.*



### DANGER!

*Regularly check the rims for damage and wear. Heavily worn rims are more prone to damage. Rim brakes accelerate the wear of a rim. A bent, cracked or broken rim can cause severe accidents.*



### TIP!

*For more information on the wear indicator for rims with rim brakes please refer to page 21.*

---

# REPAIRING A FLAT TIRE

---

Riese & Müller E-Bikes are fitted with tires that are highly puncture-resistant. For this reason it is very unlikely that you will be faced with a puncture during one of your rides.



## TIP!

*For detailed information on how to repair a puncture, please contact your specialist dealer or obtain the respective literature.*

---

# STAND

---

## ATTACHMENT OF THE STAND

Regularly check the screw connections between the stand and the frame. Please refer to the table on page 46 for the correct tightening torques.

## STANDS ON HS MODELS

In accordance with EU regulations, the HS models by Riese & Müller are fitted with an automatically folding stand (does not apply to Switzerland). Please note that this makes your HS model more prone to falling over and getting damaged or damaging other vehicles.



## ATTENTION!

*A loosened screw connection can damage the stand's mounting parts.*

---



# LIGHTING SYSTEM

On Riese & Müller E-Bikes, the light is turned on and off on the display. On fast E-Bikes (HS models) on the other hand, the lights are automatically turned on all the time (daytime running lights).

## ADJUSTING THE FRONT LIGHT

- The centre of the area illuminated by the front light mustn't hit the road more than 10 m away from the E-Bike.
- To rectify this, loosen the fixing screw and angle the front light as required. Retighten the screw.



## DANGER!

*Never use your E-Bike without a properly functioning lighting system. Never ride without a sufficiently loaded battery. In the dark, you can easily be missed by other motorists and cyclists or miss hazards and obstacles yourself, which can cause serious accidents.*

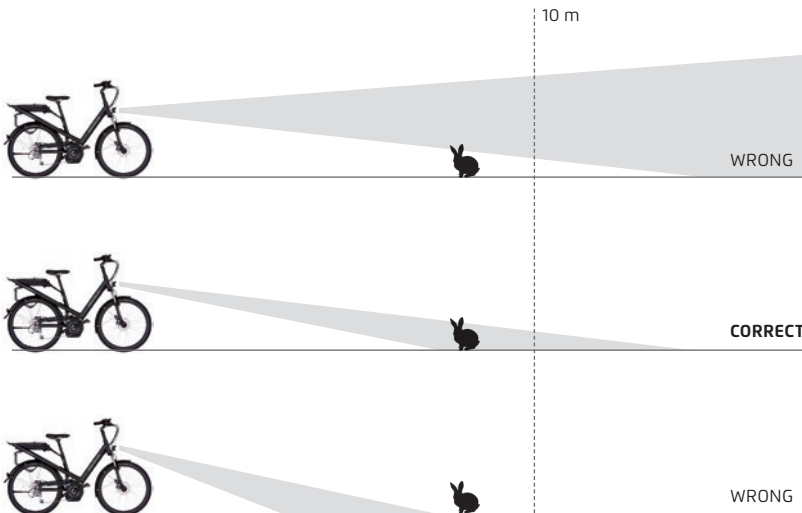

---

# LUGGAGE AND CHILD TRANSPORT

---

## CARRIER FOR RACKTIME SNAPIT SYSTEM

Many Riese & Müller models can be used with the Racktime snapit system (see [www.racktime.com](http://www.racktime.com)). This facilitates the attachment of baskets. Please observe the maximum permitted load (see page 45).

## TRANSPORTING CHILDREN AND LOADS

Before setting off with a loaded E-Bike or child seat, check the following:

- Has the basket or child seat been fixed correctly?
- Is the child wearing a seatbelt or has the load been sufficiently secured to prevent it from slipping or falling out?
- Did you make sure that the permitted overall weight has not been exceeded?
- Is the child wearing a helmet?
- Did you ensure that nothing can get into the spokes?
- Is the tire pressure high enough?
- Is the weight of the load distributed evenly?
- Did you make sure that lighting or reflectors aren't covered up?



## DANGER!

*Do not ride if one of the points specified does not apply. If fixed insufficiently, the basket and/or child seat can come loose and cause serious accidents.*



## DANGER!

*Child seats must not be attached to the seatpost. Make sure that the child is unable to touch the springs and movable parts on saddle and seatpost with its fingers as this would pose a great risk of injury! Only use a tested and safe child seat. Prevent the child's feet from touching any moving parts such as the spokes. When the E-Bike is parked using the stand, the child must not remain in the child seat.*



## ATTENTION!

*Riding behaviour is altered by a full load and the braking distance is longer. Carefully familiarise yourself with the different riding behaviour of the fully-loaded bike.*

---

---

---

**!** **NOTE!**

*Ask your specialist dealer if and which child seat can be fitted to your E-Bike.*

**!** **NOTE!**

*In Germany, only children up to the age of 7 years can be transported in a child seat. The rider needs to be at least 16 years old. Find out about the applicable legislation in your respective country.*



**ATTENTION!**

*Transporting children in child trailers may be forbidden for fast E-Bikes. Contact the respective road authority to find out about the currently applicable legislation.*

---

---

## INTEGRATED CABLE LOCK

---

The Avenue and Culture models come with a cable lock integrated into the frame. The same key fits both the cable lock and the battery lock.

To lock your E-Bike (e.g. to a fence or signpost) pull the lock cable out of the frame, put it around the chosen object and push the cable end into the opening **A**.

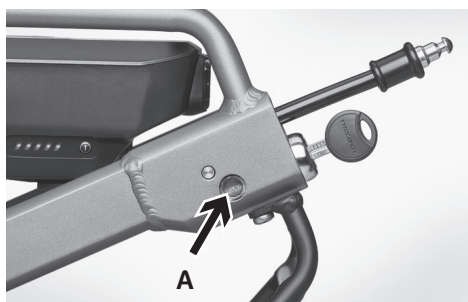

# BOSCH DRIVE

All Riese & Müller models are fitted with a Bosch drive. Carefully read the separately supplied Bosch instructions and the information about handling the battery and charger.



## DANGER!

*In order for your E-Bike's electric drive to operate correctly and safely, it needs to be checked by your specialist dealer as part of an inspection. If you notice damages to the electric system, immediately remove the battery from the E-Bike and take it to your specialist dealer for a repair. Also get in touch with your specialist dealer if you have questions, problems or notice a fault. Lack of expertise can cause serious accidents.*



## NOTE!

*Please note that your E-Bike will not produce any light if you are riding without a battery or with the system turned off.*



## DANGER!

*Remove the battery before transporting your E-Bike or carrying out any assembly, maintenance or other work on it. The unintentional activation of the electric system can cause injuries.*



## NOTE!

*Observe the instructions on the charger before starting to charge the battery. Only use the original charger or one that has been approved by the manufacturer. Once the battery is fully charged, remove it from the charger and unplug it.*



## DANGER!

*Do not use the charger in a flammable environment. For safety reasons, the charger and the battery need to be placed on a dry and non-flammable surface.*



### **DANGER!**

*A faulty battery must neither be charged nor used.*



### **ATTENTION!**

*Do not open the battery due to the danger of a short circuit. This would also render your warranty void.*

*Protect your battery from mechanical damage, heat (including constant solar radiation), fire and immersion in water. There is a risk of explosion. Vapours can escape if the battery is damaged or used incorrectly.*

*Keep children away from the battery.*



### **DANGER!**

*Never send off the battery yourself. A battery is classed as hazardous material and can overheat and catch fire under certain conditions.*

---

## E-BIKES – RANGE IN COLD WEATHER

---

Your E-Bike's electric components are designed to work faultlessly down to  $-10^{\circ}\text{C}$ .

Cold temperatures reduce your E-Bike's range. This is a normal physical process and doesn't constitute a fault or defect. When using your battery in warmer temperatures, you will be able to make use of its full energy content again.

On cold days we recommend that you store and charge the battery at room temperature over night and start riding your E-Bike immediately after reinserting the battery. The current drain warms up the battery allowing you to achieve a good range even in cold weather.

Nevertheless, it is advisable to plan shorter trips or ride with a lower level of assistance during winter.

## TRANSPORT BY TRAIN

Find out about the formalities and make the necessary reservations before your trip.

## TRANSPORT BY PLANE

E-Bikes may not be transported by plane. Li-ion batteries are classed as hazardous material and not approved for transport on planes.

## TRANSPORT BY CAR ON A BICYCLE CARRIER

Ask your dealer for a test fitting if you are interested in a bicycle carrier. Make sure the carrier securely encloses the tubes and provides stable support. The carrier mustn't be fixed to cranks or other components. Adapt your speed and way of driving to the additional load and altered driving behaviour.



### ATTENTION!

*Keep in mind that your vehicle will be larger due to the added dimensions of the carrier and bike.*

---



### ATTENTION!

*Some bike carrier clamps can damage the frame tubes. Contact your specialist dealer if you are in any doubt.*

---



### NOTE!

*For safety reasons, remove the battery before transporting your bike by car.*

---

# GENERAL CARE INSTRUCTIONS

---



## DANGER!

*Remove the battery before doing any work on your E-Bike, such as maintenance or care. The unintentional activation of the electric system can cause injuries.*

## REGULAR MAINTENANCE

When you pick up your E-Bike, your specialist dealer will already have assembled it in a condition ready to ride. Nevertheless, you need to care for your bike on a regular basis and have your specialist dealer carry out the necessary maintenance work at the specified intervals to guarantee the lasting and safe function of all parts.

## WASHING AND CARING FOR YOUR BIKE

Sweat, dirt and salt from winter road maintenance or sea air can damage your bike. You should therefore regularly clean your E-Bike and protect it against corrosion. Use clear water for cleaning and a little bit of washing-up liquid if necessary to dissolve grease residues. After drying your bike, treat surfaces with a care product available from your specialist dealer. Finally, wipe all parts with a clean, soft cloth.



## ATTENTION!

*Only take on tasks for which you have the necessary specialist knowledge and tools.*

---



## ATTENTION!

*Do not clean your E-Bike with a strong water jet or steam jet from a short distance. The water can get passed the seals and get inside the bearings. Lubricants are diluted, increasing friction. In the long run, the bearing surfaces will deteriorate.*

---



---

---

## MAINTAINING ANODISED SURFACES

The aluminium parts of your Riese & Müller E-Bike are protected by a special anodisation. This layer is particularly hard and thus relatively scratch-resistant. Despite these positive characteristics the anodic coating requires care.



### **DANGER!**

*Do not use any care products or chain lube on brake pads, brake discs and the rims' brake surfaces. Otherwise the brakes could fail causing accidents and serious injuries.*

## E-BIKE STORAGE

It is recommended to keep your E-Bike in a dry, shady and well-ventilated space.

## WINTER STORAGE

- During a long period of storage, the tubes gradually lose pressure, which can damage the tires. For this reason it is advisable to hang your E-Bike up for storage and regularly check the tire pressure.
- Clean the bike and protect it against corrosion.
- Store the bike in a dry space.
- Before storing your bike for the winter, charge the battery to approx. 60 % and recharge it to 60 % every three months.

---

# INSPECTIONS

---



## **DANGER!**

*Like all mechanical components, the bike is exposed to wear and high strain. Different materials and components can react in different ways to wear and tear caused by load. If the planned duration of use of a component is exceeded, the component can fail suddenly, possibly injuring the rider. Any type of crack, surface irregularity or discolouration in areas subject to high strain indicates the component is reaching the end of its service life; the component should then be replaced.*

After the run-in period you should have your E-Bike maintained at regular intervals.

The times specified in the table in the appendix (pages 48 - 50) are given as an indication for cyclists who ride between 1,000 and 2,000 km per year.

If you regularly ride on very poor roads, reduce the service intervals. This also applies for frequent riding in rain and humid climate.



## **ATTENTION!**

*For your own safety, take your E-Bike for its first inspection with your specialist dealer after 200 to 400 km or at the latest after three months.*

---

---

---

## **ENVIRONMENTAL TIPS**

### **General care and cleaning agents**

Consider the environment when cleaning and caring for your bike. Use biodegradable care and cleaning products whenever possible. Prevent cleaning agents from draining into the sewer system.

### **Brake cleaners and lubricants**

Handle brake cleaners and lubricants in the same way as the general care and cleaning agents.

### **Tires and tubes**

Tires and tubes are not classed as general or household waste and need to be disposed of at a recycling centre.

### **E-Bike batteries**

E-Bike batteries are not classed as household waste. They need to be handled as hazardous materials and are thus subject to specific labelling requirements. It is imperative for batteries to be disposed of through a specialist dealer or the manufacturer.

---

# LEGAL WARRANTY / GUARANTEE

---

Riese & Müller is obliged by law to ensure, among other things, that your E-Bike does not exhibit any faults that reduce or void its value or suitability. Your entitlement to this protection ends two years after the purchase of the E-Bike. The warranty claim is directed at the respective seller. In a first step there is a claim for supplementary performance, in particular repair or replacement. Warranty claims only exist for initial faults that were already present at the time of handover. In the first six months after handover it is assumed that any fault that occurs is an initial fault. Regardless of the legally prescribed liability for defects, Riese & Müller grants a five-year guarantee for breakage of the frame or rear swing arm.

This warranty, which goes beyond the requirements of statutory legislation for defect liability, will only apply if the following points are met:

- You are the first owner of the E-Bike.
- You have registered your E-Bike within four weeks from the purchase date through the following link: <https://www.r-m.de/en-us/service/warranty/>
- The E-Bike logbook in the appendix has been completed and all of the inspections listed there have been carried out and recorded by the dealer.

In the event of a claim, the fully completed bike logbook, together with the frame or entire cleaned bike, must be sent in. So please keep this documentation in a safe place. We will replace the faulty frame or rear

swing arm. Labour costs for conversion and shipping costs will be charged. This warranty only applies to the first person to purchase the bike. Any claims outside this warranty, e.g. for compensation or inability to use the bike, will not be entertained. The original duration of the warranty is not extended by any warranty service.

Damage caused e.g. by wear, neglect (failure to maintain and care for the bike), crashes, excessive strain caused by excess loads, incorrect assembly and handling, any changes to the E-Bike (attachment or modification of additional components) or tuning is not covered by this warranty.

No warranty claims can be made if the bike is used in competitions, jumps or if exposed to extreme strain of any other type.

The terms described here do not apply to commercial use.

The battery of your E-Bike is a wearing part. The electronic components within are subject to the statutory warranty of two years. We guarantee that the battery will still have a capacity of 60% after two years or 500 charge cycles (depending on which happens first).

---

---

## INFORMATION ON WEAR AND TEAR

Some components of your bike are subject to wear owing to their function. The extent of wear depends on the care, maintenance and nature of the use of the E-Bike (mileage, riding in rain, dirt, salt, etc.). Bikes that are often left outside can also be subject to increased wear due to weathering. The parts must be replaced once they reach their wear limit.

This includes:

- the drive chain or toothed belt
- the brake cables
- the rubber hand grips
- the sprockets, pinions or toothed belt discs
- the gear cables
- the tires
- the saddle cover
- the brake pads
- the rims or brake discs.

The brake pads of rim and disc brakes are subject to wear owing to their function. If the E-Bike is used for sports purposes or for riding in mountainous terrain, it may be necessary to change the brake pads more frequently. Check the condition of the pads regularly and, if necessary, have them replaced by a specialist dealer. In the case of rim brakes it is not just the pads that wear down, but the rim too. Therefore check the rims regularly e.g. when pumping up the tire. Rims have a peripheral groove as an indicator of wear. If this groove can no longer be

seen, the rim must be replaced. If deformations or fine cracks appear in the sides of the rims when air pressure is increased, this indicates the end of the service life. The rim must then be replaced immediately.

Brake discs also wear out. Regularly have the thickness of the brake discs checked as part of inspections and replace the components, if necessary.

Replacing these parts due to wear, is not subject to the statutory warranty obligation.

The bearings and seals for suspension forks and spring-loaded rear stays are in constant motion when the chassis is working. Environmental factors cause wear on these moving parts. These areas must be regularly cleaned and maintained. Depending on the operating conditions, it cannot be ruled out that parts will have to be replaced due to wear, e.g. if bearing play starts to occur.

---

# LEGAL WARRANTY / GUARANTEE

---

Point of contact for complaints and servicing is solely the Riese & Müller specialist dealer. On request we will be glad to inform you of a nearby dealer (dealers can also be found online at [www.r-m.de/en-us/](http://www.r-m.de/en-us/)).

Furthermore, we would point out that you must contact your dealer before arranging repairs in order to ensure the quickest and most cost-effective way to deal with your issue. Please note the following instructions if your E-Bike has to come to the dealer's or our workshop: Services and repairs are only performed on sufficiently cleaned wheels. Remove all individual parts before shipping (computer, rear mirror, trailer couplings, locks, quick-release couplings, etc.).

Services are performed using the guideline values of the standard bike equipment. Individual parts are only restored to a reasonable extent in this sense. No wear parts are replaced or inspections performed during servicing. In addition, payments and materials are handled exclusively through the specialist dealer. Make sure that you or your dealer place sufficient postage on the packaged item.

In the interest of durability and long service life of the components, the manufacturer's assembly specifications (including torque for screws) and the specified maintenance intervals must be complied with.

Failure to comply with the assembly specifications and inspection intervals can void the warranty and liability for defects. Please note the inspections outlined in your manual or the exchange of safety-related components such as handlebars, brakes etc. that may be required in some circumstances.

The currently applicable standards, tests and checks assume an average service life of 10 years or 16,500 km to 20,000 km of E-Bikes (depending on which occurs first). In accordance with the high quality standards, Riese & Müller assumes a mileage about three times higher for its frames and forks. However, the strain on an E-Bike depends heavily on the load, the condition of roads and the riding style. If you regularly put an above-average strain on the E-Bike due to heavy loads (overall vehicle weight over 110 kg), poor roads (e.g. cobblestones, potholes, kerb stones) or otherwise, you should assume a reduced service life in compared to industry standards.

Once the product has reached the end of its service life, road safety is no longer warranted.

# WEIGHT SPECIFICATIONS

MODEL	PERMITTED OVER-ALL WEIGHT	E-BIKE WEIGHT	MAX. RIDER WEIGHT	MAX. CARRIER LOAD <sup>1</sup>	MAX. FRONT CARRIER LOAD
Avenue	140 kg	26.6 – 27.3 kg	110 kg	20 kg <sup>1</sup>	—
Culture	140 kg	26.7 – 27.5 kg	110 kg	20 kg <sup>1</sup>	—
Delite	140 kg	23.0 – 28.0 kg	110 kg	20 kg <sup>1</sup>	—
Homage	140 kg	25.7 – 26.8 kg	110 kg	20 kg <sup>1</sup>	—
Kendu	140 kg	25.8 – 25.9 kg	110 kg	20 kg <sup>1</sup>	—
Load	190 <sup>3</sup> /200 kg	32.6 – 35.1 kg	100 kg <sup>2</sup>	20 kg <sup>1, 2</sup>	100 kg
Packster	200 kg	34.9 – 52.9 kg <sup>4</sup>	110 kg	17 kg <sup>1</sup>	100 kg
Tinker	135 kg	21.9 – 23.8 kg	110 kg	20 kg <sup>1</sup>	—
Charger	140 kg	19.9 – 26.6 kg	110 kg	17 kg <sup>1</sup>	3 kg <sup>1</sup>
Charger GH	160 kg	27.2 kg	135 kg	17 kg <sup>1</sup>	—
Cruiser	140 kg	24.8 – 25.8 kg	110 kg	30 kg <sup>1</sup>	3 kg <sup>1</sup>
Nevo	140 kg	24.3 – 26.2 kg	110 kg	17 kg <sup>1</sup>	—
Roadster	140 kg	21.9 – 22.5 kg	110 kg	20 kg <sup>1</sup>	—
Swing	130 kg	24.9 – 26.1 kg	100 kg	25 kg <sup>1</sup>	3 kg <sup>1</sup>

<sup>1</sup> Including the basket's / child seat's own weight

<sup>2</sup> The weight of the rider and the load on the carrier mustn't exceed 120 kg for the Load

<sup>3</sup> HS models

<sup>4</sup> Weight may vary depending on the selected loading surface option.

# TIGHTENING TORQUES FOR SCREW CONNECTIONS

COMPONENT	SCREW CONNECTION	TORQUE
Back-pedal brake anchor	Fixing screw	4-6 Nm
Brake lever	Fixing screw	5-6 Nm
Suspension element	Fixing screw	7-9 Nm
Freewheel hub	Cogset guard	29-49 Nm
Delite carrier	Fixing screws	8-10 Nm
Rear swing arm bearing	Clamping screw	5 Nm
Hydraulic brakes	Fixing screws	*
	Hydraulic brakes fixing screws	*
Crankset	Crankbolts	35 Nm
	Chaining bolts	8-11 Nm
Hub	Quick-release lever	9-12 Nm
	Lock nut for bearing adjustment with quick-release hubs	10-25 Nm
	Axle nuts in gear hubs: · Shimano hubs	30-45 Nm
	· Rohloff hub	30-35 Nm
	· SRAM Dual Drive hub	35 Nm
Pedals		35 Nm
Pletscher stand	Fixing screws M6	12-14 Nm
Rohloff gear		*
Seatpost	Fixing screw for saddle clamp 1/2 headed screw	12-15/9-12 Nm
	Clamping screw on the seat tube	9-12 Nm
Shifter	Shimano shift lever	4-6 Nm
	Twist shifter	1-2 Nm
Rear derailleur	Fixing screws	8-10 Nm
	Tension clamping screw	4-6 Nm
	Jockey pulley pin	3-4 Nm
Mudguards	Fixing screws on the frame front/rear	3-4 Nm
Derailleur	Fixing screws	5-7 Nm
	Tension clamping screw	4-6 Nm
V-Brake	Fixing screw on the frame base	5-9 Nm
	Tension clamping screw	6-8 Nm
A-Headset stem	Handlebar clamp 2/4 screws	10/5.5 Nm
	Shaft clamping screw	12-14 Nm

\* see separately supplied component manufacturers' manuals



## LOAD/PACKSTER: TIGHTENING TORQUES FOR SCREW CONNECTIONS

COMPONENT	SCREW CONNECTION	TORQUE
Frame	Connection between front and rear frame: 4 screws M10	30-40 Nm
	2 screws M8	18-20 Nm
Suspension fork	Shaft clamp top on headset (2 screws)	12-14 Nm
	Clamping steering arm at right fork tube: 4 screws M5	5-6 Nm
	Joint head on steering arm (M8)	12-14 Nm
Steering linkage	Lock nut M8, joint head on steering linkage	9-12 Nm
	Front and rear end steering linkage: Screw and nut M6	9-12 Nm
	Cardan joint: Screws and nuts M8	12-14 Nm
Stand	Lock nuts M8	12-14 Nm
	Ring screws and nuts M5 for stand spring	5-6 Nm

## STEM KENDU/LOAD: TIGHTENING TORQUES FOR SCREW CONNECTIONS

COMPONENT	SCREW CONNECTION	TORQUE
Stem	Clamping screws M6 (4 pieces)	7-9 Nm
	Front clamping screws M6 (2 pieces)	7-9 Nm
	Rear clamping screws M5 (2 pieces)	3-4 Nm
	Grub screws quick-release skewer for angle adjustment (2 pieces)	1 Nm

# SERVICE AND MAINTENANCE PLAN

You can perform the inspections marked with • yourself if you have technical skills, a little experience and suitable tools e.g. a torque wrench.

If faults are detected during inspections, take appropriate measures immediately. Your specialist dealer will be happy to help if you have any questions or if anything is unclear.

Work marked with ✕ should only be carried out by the specialist dealer as part of an annual service.

COMPONENT	ACTION
Lighting	Check fixing screws for secure seating
Tires	Check air pressure Check tread height and side walls
Brakes	Check lever stroke, pad thickness, position to the rim
Brake cables	Visual check
Brake cable housings	Visual check for tightness
Suspension element	Maintenance (see from page 28), functional test
Suspension fork	Check for play and tightness, functional test
Rims	Check wall thickness/wear indicator, replace if necessary
Rear swing arm	Check function and bearing play
Chain (dérailleur gear)	Check and lubricate if required Check wear and replace if necessary
Chain (hub gear)	Check and lubricate if required Check wear and replace if necessary
Crank	Check and re-tighten if required, check wear on chainwheel
Paint	Preserve
Wheels	True running and spoke tension Axle nuts/quick-release skewer
Handlebars / stem	Visual check Replace
Handle grips with screw clamping	
Headset	Check bearing play Re-lubricate
Metal surfaces	Preserve (Except rims, brake discs)
Hubs	Check bearing play, lubricate
Pedals	Check bearing play, lubricate
Belt drive	Check for wear, replace belt if necessary
Saddle clamp	
Seatpost	Clean seat tube, lubricate
Rear dérailleur	Clean, lubricate
Disc brakes	Screw connection brake discs and calipers
Quick release skewers	Check tightness
Screws and nuts	Check and retighten if required
Mudguard attachment	
Valves	Check tightness
Gear/brake cables	Remove and lubricate or replace

## NOTE!

*Only use original or equivalent parts when replacing wear parts and safety-related parts.*

BEFORE EVERY RIDE	MONTHLY	YEARLY	OTHER INTERVALS
•			
•			
	•		
•	• (Disc brakes)		
	•		
•			• Every 5,000 km
		✘	Clean and lubricate monthly, see suspension manufacturer's specifications.
			✘ at the latest after the second set of brake pads
		✘	
	•		✘ From 1,500 km
			• Every 1,000 km
			✘ From 3,000 km
		✘ <sup>1</sup>	
		•	
	•		
		• <sup>1</sup>	
		✘ <sup>1</sup>	
			✘ After a fall, 25,000 km or 5 years – whichever occurs first
		• <sup>1</sup>	
	•		
		✘	
		•	
		✘	
		✘ <sup>1</sup>	
			from 5,000 km
		• <sup>1</sup>	
		•	
	•	✘ <sup>1</sup>	
		✘ <sup>1</sup>	
•			
	•		
		✘ <sup>1</sup>	
•			
		✘	

<sup>1</sup> These screw connections should be checked every year by the specialist dealer using a torque tool.

---

# IMPORTANT DOCUMENTS

---

The appendix of this manual includes:

- The Riese & Müller E-Bike Logbook, where all inspections carried out by the specialist dealer are recorded. In the event of a warranty claim, the completed E-Bike Logbook has to be sent to Riese & Müller along with a copy of the customer's purchase receipt. All inspections listed in the E-Bike Logbook have to be carried out and recorded by the specialist dealer.
- A service and maintenance plan on pages 48-49.
- A list of recommended tightening torques for all your E-Bike's important components on pages 46-47.  
Your specialist workshop will need this for repairs and inspections.
- A handover protocol describing the details of the E-Bike's handover from the specialist dealer to the customer.

Enclosed you will find:

- If applicable, separate manuals supplied by component manufacturers. This manual refers to these specific and detailed manuals in several places. They include all relevant information about use, maintenance and care. Make sure that the respective manuals for the gear and brake components are in your possession and keep them in a safe place along with this manual.
- The declaration of conformity for E-Bikes on page 3 of the Bosch manual
- The purchase receipt proving that you are the first owner of the E-Bike and since when.

---

# HANDOVER DOCUMENTATION FOR CUSTOMER AND DEALER

---

Dear dealer,

Please go through the following handover protocol with the customer and ask them to confirm this with their signature. Keep a copy of the handover protocol for your records.

- Handover of the invoice to the customer, invoice needs to include purchase date, exact E-Bike description incl. frame size, frame number, Bosch Display number and battery number(s).
- Adjust the seat height to the customer. For E-Bikes with quick-release skewer on the seatpost: Explain adjustment to the ideal seat height.
- Adjust handlebars, brake and shift levers to the customer.
- Clarify with the customer which brake lever operates the front brake.
- For E-Bikes with adjustable stem: Adjust the stem to the customer, explain the adjustment mechanism.
- Adjust the suspension to the customer and explain the operation.
- Customer has been made aware of the controls for the electric drive system and gear.
- Explain the operation of quick-release skewers and axles.
- Customer has received all manuals that are supplied along with the E-Bike.
- Customer has been informed about the intended use.
- Customer has been informed about the maximum permitted overall weight.
- Customer took a test ride.
- Customer has been advised to cautiously get used to the brakes away from traffic.

.....  
Customer signature:

.....  
Dealer signature:

.....  
Location

.....  
Date

---

# E-BIKE LOGBOOK

---



## **ATTENTION!**

*You are the first owner of the E-Bike.  
Complete the E-Bike Logbook in the  
appendix and have your specialist  
dealer carry out and record all the  
listed inspections.*

---

---

---

Model:

Colour:

Number of gears:

Frame number:

Battery number:

Purchase date:

**HANDOVER TOOK PLACE:**

Place:

Date:

Dealer stamp:

Dealer signature:

Please have all inspections carried out by your specialist dealer recorded in this E-Bike Logbook. In the event of a claim, the warranty, which goes beyond the requirements of statutory legislation, will only apply if the completed E-Bike logbook is sent to Riese & Müller along with a copy of the customer's purchase receipt and if all inspections specified in the logbook have been carried out and recorded by a specialist dealer.

---

# E-BIKE LOGBOOK

---

## 1. Inspection

At the latest after 400 km or  
three months after purchase:

Replaced or repaired parts:

Order no.: Date:

Dealer stamp and signature:

---

## 2. Inspection

At the latest after 2,000 km or  
one year after purchase:

Replaced or repaired parts:

Order no.: Date:

Dealer stamp and signature:

---

## 3. Inspection

At the latest after 4,000 km or  
two years after purchase:

Replaced or repaired parts:

Order no.: Date:

Dealer stamp and signature:

---



<p><b>4. Inspection</b> At the latest after 6,000 km or three years after purchase:</p>	<p>Replaced or repaired parts:</p>
<p>Order no.: Date:</p>	
<p>Dealer stamp and signature:</p>	
<p><b>5. Inspection</b> At the latest after 8,000 km or four years after purchase:</p>	<p>Replaced or repaired parts:</p>
<p>Order no.: Date:</p>	
<p>Dealer stamp and signature:</p>	
<p><b>6. Inspection</b> At the latest after 10,000 km or five years after purchase:</p>	<p>Replaced or repaired parts:</p>
<p>Order no.: Date:</p>	
<p>Dealer stamp and signature:</p>	

---

# E-BIKE LOGBOOK

---

<b>7. Inspection</b> At the latest after 12,000 km or six years after purchase:	Replaced or repaired parts:
Order no.: Date:	
Dealer stamp and signature:	
<b>8. Inspection</b> At the latest after 14,000 km or seven years after purchase:	Replaced or repaired parts:
Order no.: Date:	
Dealer stamp and signature:	
<b>9. Inspection</b> At the latest after 16,000 km or eight years after purchase:	Replaced or repaired parts:
Order no.: Date:	
Dealer stamp and signature:	

---

---

# NOTES

---

A series of horizontal dotted lines for writing notes.

---

# NOTES

---

A series of horizontal dotted lines for writing notes.

© 2017, Riese & Müller GmbH

Text and concept  
Riese & Müller GmbH

Graphic design  
[www.wolf-corporate.de](http://www.wolf-corporate.de)

Photography  
Kay Tkatzik, Riese & Müller GmbH

04/2017, 897602

This manual complies with the  
European standard EN 15194

# RIESE & MÜLLER

---

Riese & Müller GmbH  
Feldstrasse 16  
64331 Weiterstadt  
Germany

---

team@r-m.de  
www.r-m.de  
T: +49 61 51-366 86-0  
F: +49 61 51-366 86-20



Scan the QR code with your smartphone  
for direct access to the latest version of  
all manuals. Or visit our website:  
[www.r-m.de/en-en/service/downloads](http://www.r-m.de/en-en/service/downloads)

---